

XT series General Purpose VRLA batteries are designed with AGM(Absorbent Glass Mat) technology. XT series offers 5 years($\leq 20Ah$) and 10 years($\geq 20Ah$) full maintenance free design life. With a compact design and good reliability, this series is highly suited for security and alarm systems, UPS systems, emergency light systems and other small backup applications.

6V Voltage	200Ah Capacity	AGM Technolog	General Purpose
---------------	-------------------	------------------	--------------------



Complied standards

- IEC 60896-21/22
- JIS C8704
- GB/T19639

Features and Benefits

- Wide operating temperature range from -15°C to 50°C
- Can be used at vertical or horizontal orientation
- Balanced design for both floating and cyclic operation
- Maintenance-free operation
- Low self-discharge rate and long shelf life

Applications

- Alarm systems
- Communication Equipments
- Control equipments
- Security systems
- Medica Equipments
- UPS systems
- Power tools
- Toys
- Emergency Power Systems
- Photovoltaic Systems
- Security Systems

Technical Specifications

Nominal Voltage.....	6V (3 cells per unit)
Nominal Capacity(20°C)	
20hour rate(10.6A,5.4V).....	212Ah
10hour rate(20.0A,5.4V).....	200Ah
5hour rate(35.2A,5.25V).....	176Ah
1hour rate(127.6A,4.8V).....	127.6Ah
Dimension(mm).....	L260 x W180 x H245 x TH252mm
Approx. Weight	30kg
Terminal Type.....	M8
Internal Resistance.....	2.4mΩ(fully Charged @20°C)
Max.Charge Current.....	40A
Max.Discharge Current (5s).....	1000A
Ambient Temperature	
Discharge.....	-15-45°C
Charge.....	-15-45°C
Storage.....	-15-45°C
Capacity Affected by Temp.(10 hr capacity)	
105% @40°C	
100% @25°C	
85% @0°C	
65% @-15°C	
Self-Discharge @20°C.....	Approx. 3% per month
Charge Voltage @20~25°C	
Float charge voltage.....	6.8V-6.9V
Equalize Charge Voltage.....	7.2V-7.5V

Dimensions

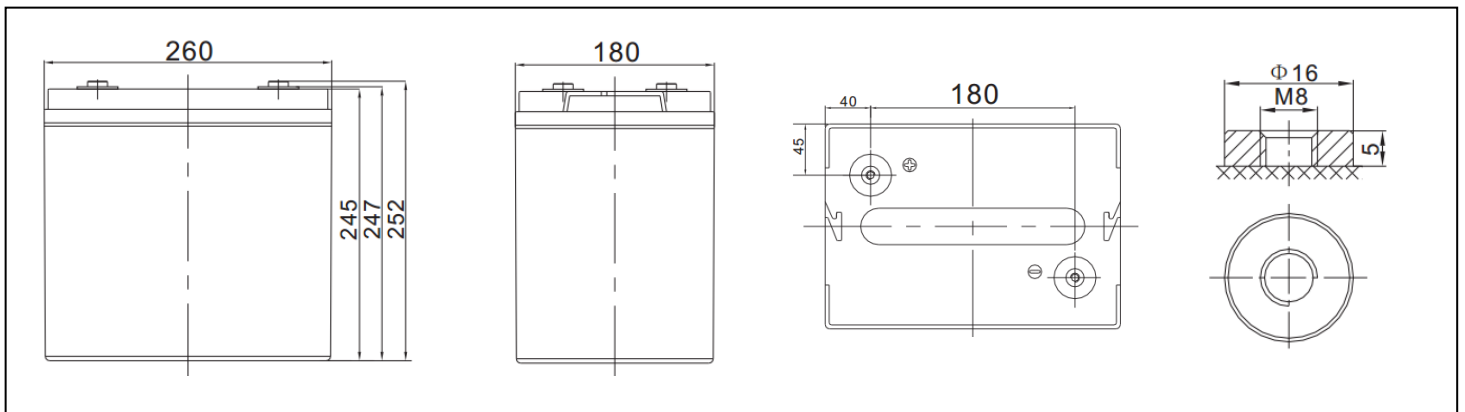

Performance Characteristics

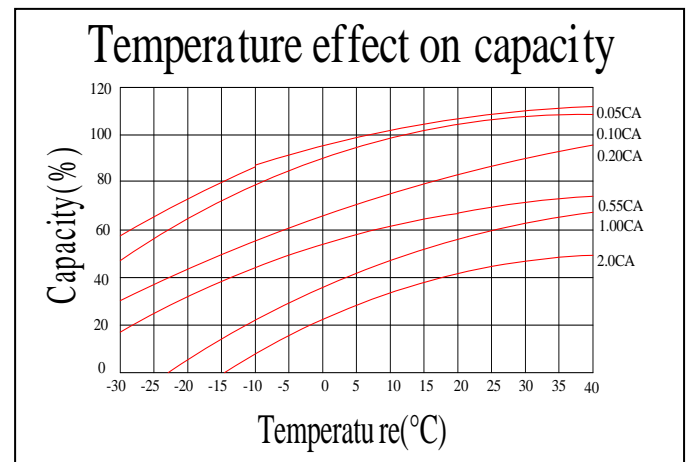
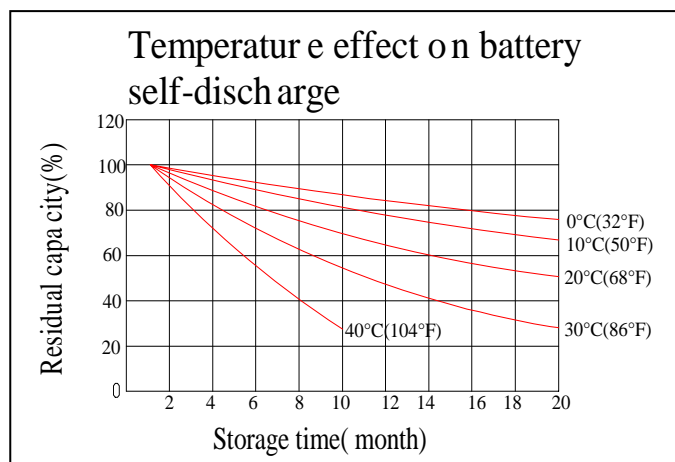
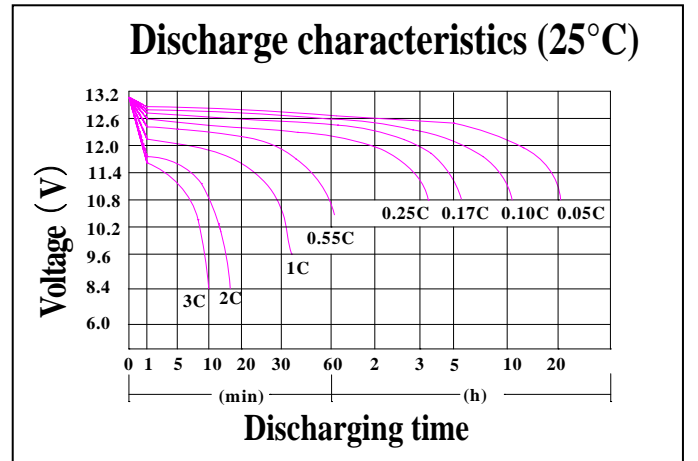
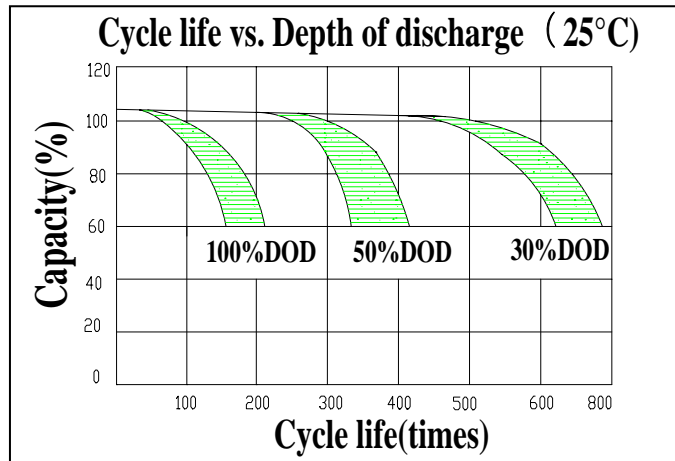
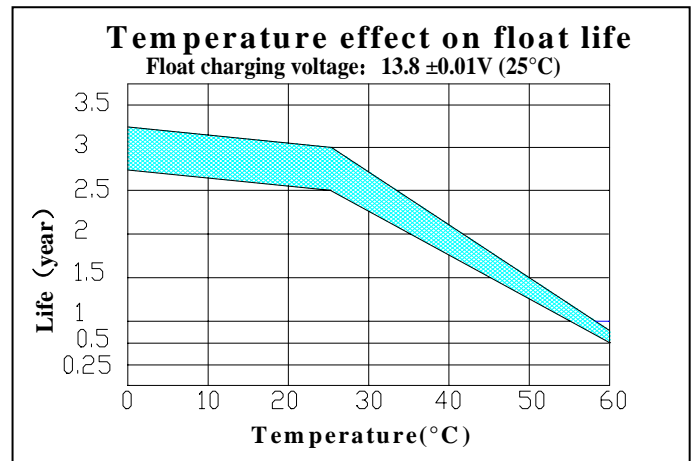
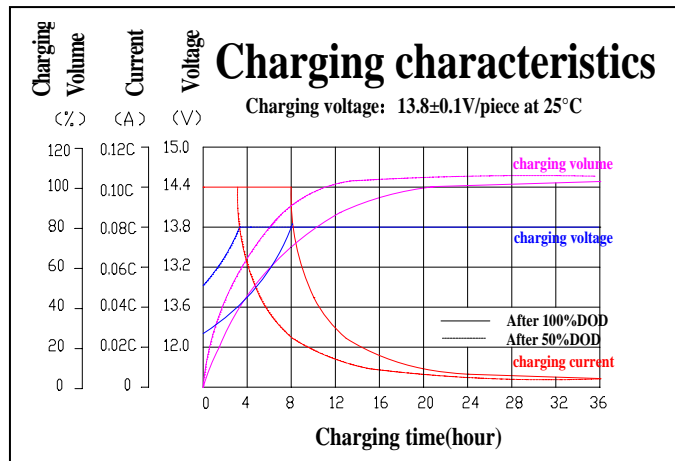

Battery Discharge

Discharge Constant Current per Cell (Amperes at 25°C)

F.V/Time	15min	30min	45min	1h	2h	3h	5h	6h	8h	10h	20h
1.60V	361.0	212.6	161.0	127.6	75.0	55.2	37.2	32.4	25.4	21.0	11.1
1.65V	341.0	201.4	154.8	123.8	72.6	53.4	36.6	31.8	25.2	20.6	11.0
1.70V	320.2	195.6	149.2	119.0	70.6	52.0	35.8	31.2	24.8	20.4	10.8
1.75V	300.0	187.0	142.6	114.2	68.8	50.8	35.2	30.6	24.4	20.2	10.7
1.80V	281.4	180.2	137.4	110.2	66.2	49.2	34.4	30.0	24.0	20.0	10.6

Discharge Constant Power per Cell (Watts at 25°C)

F.V/Time	15min	30min	45min	1h	2h	3h	5h	6h	8h	10h	20h
1.60V	690.2	422.2	305.8	244.8	142.2	105.4	71.8	62.6	49.6	41.0	21.4
1.65V	660.4	403.8	295.4	238.2	138.4	102.6	70.6	61.6	49.2	40.6	21.2
1.70V	615.4	387.2	286.0	230.0	135.2	100.2	69.6	60.8	48.6	40.2	21.0
1.75V	577.4	368.6	274.6	221.6	132.0	98.2	68.6	59.8	48.0	39.8	20.8
1.80V	542.0	353.6	265.4	214.4	127.6	95.4	67.2	58.8	47.4	39.6	20.6

(Note) The above characteristics data are average values obtained within three charge/discharge cycle not the minimum values.

Battery Construction

Component	Positive plate	Negative plate	Container & Cover	Safety valve	Terminal	Separator	Electrolyte	Pillar seal
Features	Thick high Sn low Ca grid with special paste	Balanced Pb-Ca grid for improved recombination efficiency	ABS (UL94-V0 optional)	Flame Si-Rubber and aging resistance	Female Copper Insert M8 (torque: 10~11N.m)	Advanced AGM separator for high pressure cell design	Dilute high purity sulphuric acid	Two layers epoxy resin seal