

XL series VRLA batteries are recognized as the most reliable and high quality battery system in the industry. By combining the service life reliability of a flooded battery with the performance energy density of a valve-regulated battery, XL series batteries designed with advanced AGM (Absorbent Glass Mat) technology, Long service life designed with 10 years. it is highly suited to telecom, UPS, renewable energy system, power stations and similar applications.

<b>2V</b> Voltage	<b>2500Ah</b> Capacity	<b>AGM</b> Technolog	<b>20 years</b> Design life
----------------------	---------------------------	-------------------------	--------------------------------



**Complied standards**

- IEC 60896-21/22
- JIS C8704
- GB/T19639

## Features and Benefits

- Thick plate with high Tin low Calcium alloy
- High Reliability and Good Quality
- High gas recombination efficiency
- High Power Density
- Long Service Life, in Float or Cyclic

## Construction

- Positive plate - Thick high Sn low Ca grid to resist corrosion and prolong life
- Negative plate - Balanced Pb-Ca grid for improved recombination efficiency
- Separator - Advanced AGM separator for ultra low float current
- Electrolyte - Dilute high purity sulphuric acid
- Battery container and cover - ABS
- Pillar seal - 100% factory tested, proven two layers epoxy resin seal
- Relief valve - Complete with integrated flame arrestor

## Applications

- Telecom
- Electric Utilities
- UPS systems
- Control Equipments
- Security Systems
- Medica Equipments
- Railroad Utilities
- Photovoltaic Systems
- Renewable Energy Systems

## Technical Specifications

Nominal Voltage.....	2V(1 cells per unit)
Nominal Capacity(20°C)	
20hour rate(132.5A,1.8V).....	2650Ah
10hour rate(250.0A,1.8V).....	2500Ah
5hour rate(420A,1.75V).....	2100Ah
1hour rate(1458A,1.6V).....	1458Ah
Dimension(mm).....	L490 x W350 x H341 x TH364mm
Approx. Weight .....	140kg
Terminal Type.....	Female Copper Insert M8 (torque:10~12N.m)
Internal Resistance.....	0.12mΩ(fully Charged @20°C)
Max.Charge Current.....	375A
Max.Discharge Current (5s).....	9000A
Ambient Temperature	
Discharge.....	-15-45°C
Charge.....	-15-45°C
Storage.....	-15-45°C
Capacity Affected by Temp.(10 hr capacity)	
105% @40°C	
100% @25°C	
85% @0°C	
65% @-15°C	
Self-Discharge @20°C.....	Approx. 3% per month
Charge Voltage @20~25°C	
Float charge voltage.....	2.23V-2.27V
Equalize Charge Voltage.....	2.33V-2.37V

## Dimensions

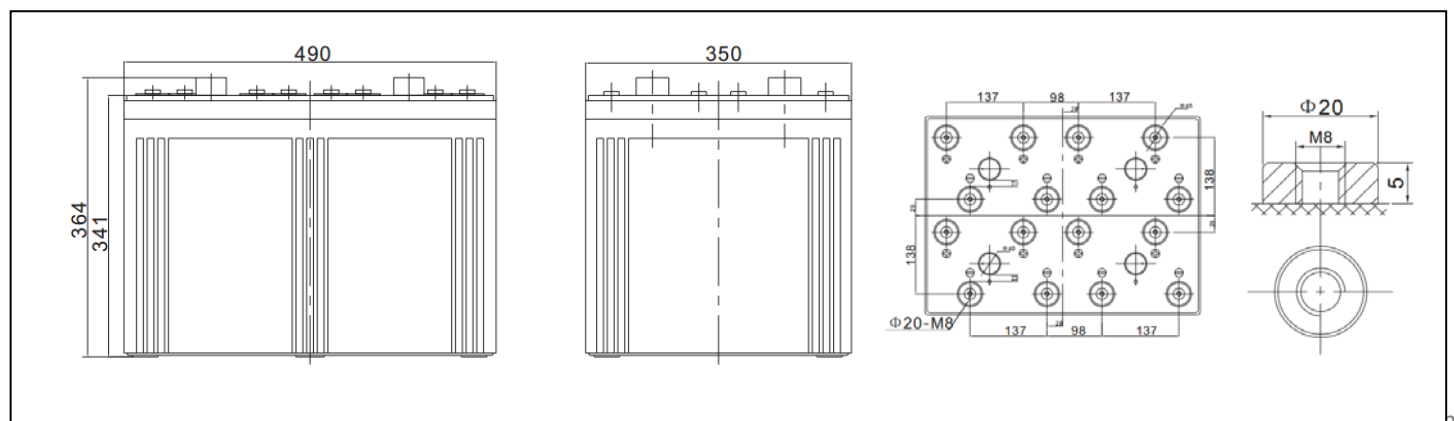

Performance Characteristics

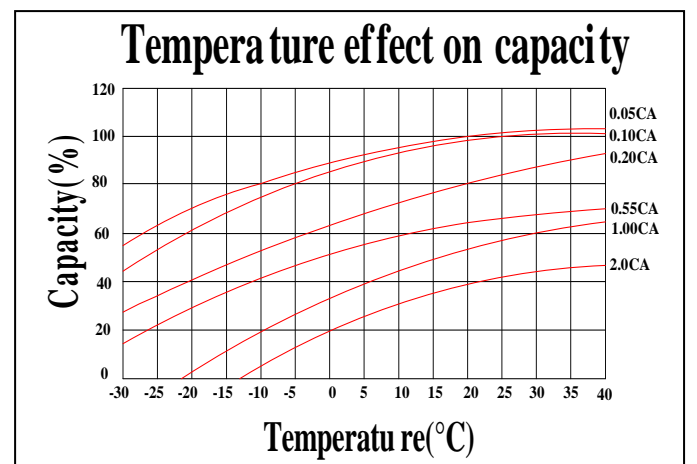
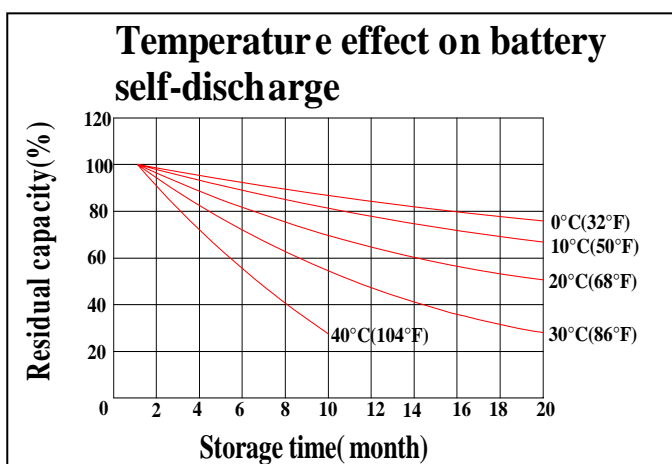
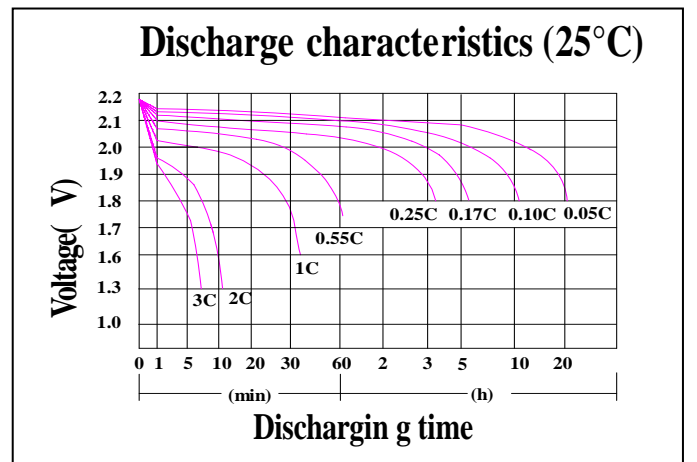
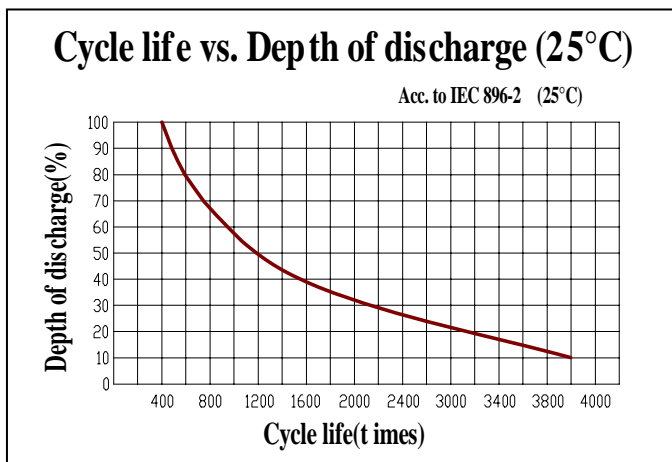
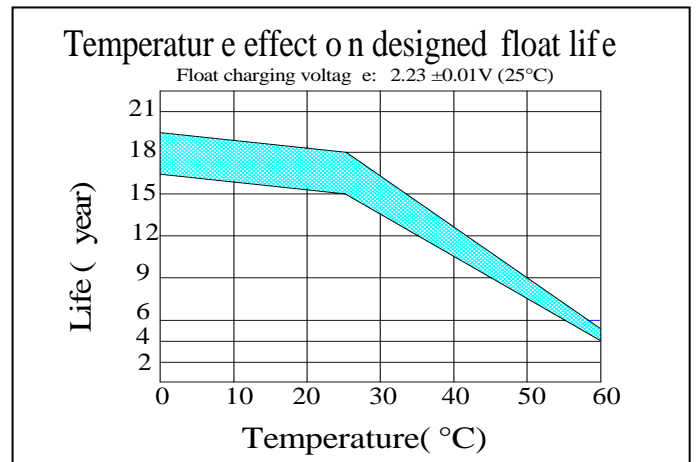
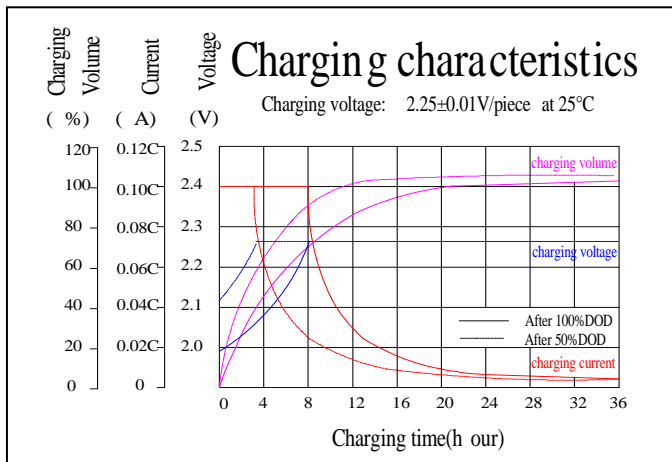

## Battery Discharge

## Discharge Constant Current per Cell (Amperes at 25°C)

F.V/Time	30min	45min	1h	2h	3h	4h	5h	6h	8h	10h	20h
1.60V	2410.0	1820.0	1490.0	894.0	675.0	544.0	458.5	397.0	314.5	261.5	137.0
1.65V	2302.5	1765.0	1450.0	873.0	661.0	536.5	452.0	391.5	310.5	258.5	135.0
1.70V	2210.5	1700.0	1405.0	847.5	646.5	525.0	442.5	385.0	306.5	255.0	134.5
1.75V	2118.0	1650.0	1365.0	823.5	630.0	514.0	435.0	378.5	301.5	252.5	133.0
1.80V	2007.0	1575.0	1310.0	790.5	607.5	497.0	422.0	369.5	296.0	250.0	132.5

## Discharge Constant Power per Cell (Watts at 25°C)

F.V/Time	30min	45min	1h	2h	3h	4h	5h	6h	8h	10h	20h
1.60V	4417.7	3380.6	2802.8	1698.0	1292.0	1046.5	887.0	773.0	617.5	516.0	271.5
1.65V	4263.1	3309.0	2746.4	1669.0	1271.5	1037.0	878.0	765.0	611.0	511.0	268.5
1.70V	4123.6	3205.2	2676.5	1627.5	1250.0	1018.5	862.5	754.0	604.0	505.5	265.5
1.75V	3985.1	3133.2	2614.0	1587.5	1222.0	1001.0	850.5	742.5	595.5	501.0	263.0
1.80V	3804.7	3008.7	2519.6	1530.5	1181.5	971.0	827.5	727.5	585.5	496.5	261.0

(Note) The above characteristics data are average values obtained within three charge/discharge cycle not the minimum values.

Component	Positive plate	Negative plate	Container & Cover	Safety valve	Terminal	Separator	Electrolyte	Pillar seal
Features	Thick high Sn low Ca grid with special paste	Balanced Pb-Ca grid for improved recombination efficiency	ABS (UL94-V0 optional)	Flame Si-Rubber and aging resistance	Female Copper Insert	Advanced AGM separator for high pressure cell design	Dilute high purity sulphuric acid	Two layers epoxy resin seal